



Cast Iron Price List

2024

Vecchio

Vecchio combines high quality cast iron elegance with a sleek modern design, offering a huge array of possibilities for both traditional and modern styles of décor. Available in either wall mounted or floor standing versions.



Shown here in Gun Metal finish with Chartwell anthracite thermostatic valves

Material:	Operating up to:	Delivery:	Colours:	Guarantee:
CI	6bar	1 week*	chart 2	10 yrs

Vecchio

Wall mounted

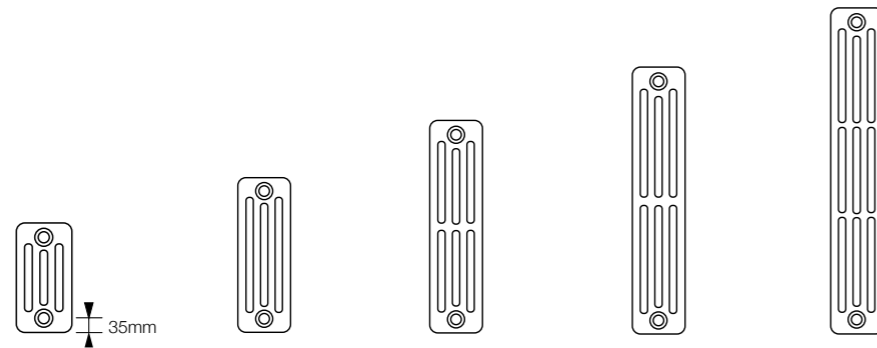

All information is per section	C33/4-B	C46/4-B	C61/4-B	C80/4-B	C95/4-B
Primer (requires overpainting)	£23.80 ex VAT £28.56 inc VAT	£27.80 ex VAT £33.36 inc VAT	£31.40 ex VAT £37.68 inc VAT	£39.00 ex VAT £46.80 inc VAT	£50.00 ex VAT £60.00 inc VAT
Classic colour finish	£33.60 ex VAT £40.32 inc VAT	£37.60 ex VAT £45.12 inc VAT	£41.20 ex VAT £49.44 inc VAT	£48.80 ex VAT £58.56 inc VAT	£59.80 ex VAT £71.76 inc VAT
Special effects finish	£55.80 ex VAT £66.96 inc VAT	£59.80 ex VAT £71.76 inc VAT	£63.40 ex VAT £76.08 inc VAT	£71.00 ex VAT £85.20 inc VAT	£82.00 ex VAT £98.40 inc VAT
Height (mm)	288	420	570	720	870
Output (watts @ Δt 50°C)	40.8	58.2	75.4	98.3	116.4
No. columns deep	4	4	4	4	4
Depth (mm) - D1	140	140	140	140	140
Depth (wall to face) (mm) - D2	172 or 182	172 or 182	172 or 182	172 or 182	172 or 182
Pipe centres from wall (mm) - D3	102 or 112	102 or 112	102 or 112	102 or 112	102 or 112
Width (mm)	50	50	50	55	55
Dry weight (kg)	2.58	3.19	4.19	5.17	6.54
Water content (L)	0.40	0.49	0.60	0.85	0.97
Max no. factory built sections #	20	20	20	20	17

* A joining tool is required for on-site assembly for longer lengths than the factory maximum number of sections.

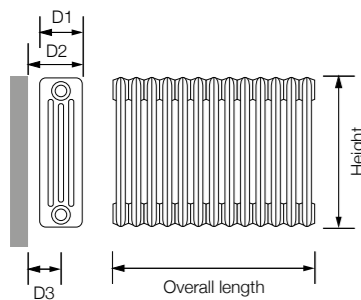

Joining key

Model / Code	ZXTOOL-01
Vecchio joining key	£160.00 ex VAT £192.00 inc VAT

We will always strive to keep on-site assembly to a minimum, but for radiators larger than the maximum factory assembled size (see charts above) on-site assembly will be required.

Full instructions and parts will be supplied, although a joining key tool will need to be purchased separately on a sale/return basis.

To calculate the length of the radiator, multiply the number of sections by the section width (see table above), then add 24mm for reducing bushes.

Please note there is a +/- 2mm manufacturers tolerance per section. We strongly recommend not setting pipework until the radiator has been delivered.

Vecchio

Floor standing

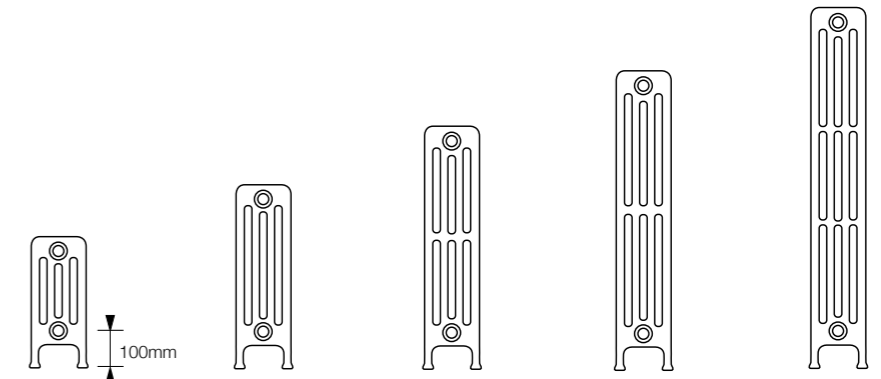

All information is per section	C33/4-F	C46/4-F	C61/4-F	C80/4-F	C95/4-F
Primer (requires overpainting)	£23.80 ex VAT £28.56 inc VAT	£27.80 ex VAT £33.36 inc VAT	£31.40 ex VAT £37.68 inc VAT	£39.00 ex VAT £46.80 inc VAT	£50.00 ex VAT £60.00 inc VAT
Classic colour finish	£33.60 ex VAT £40.32 inc VAT	£37.60 ex VAT £45.12 inc VAT	£41.20 ex VAT £49.44 inc VAT	£48.80 ex VAT £58.56 inc VAT	£59.80 ex VAT £71.76 inc VAT
Special effects finish	£55.80 ex VAT £66.96 inc VAT	£59.80 ex VAT £71.76 inc VAT	£63.40 ex VAT £76.08 inc VAT	£71.00 ex VAT £85.20 inc VAT	£82.00 ex VAT £98.40 inc VAT
Height (mm)	353	485	636	785	935
Output (watts @ Δt 50°C)	40.8	58.2	75.4	98.3	116.4
No. columns deep	4	4	4	4	4
Depth (mm) - D1	140	140	140	140	140
Depth (wall to face) (mm) - D2	172 or 182	172 or 182	172 or 182	172 or 182	172 or 182
Pipe centres from wall (mm) - D3	102 or 112	102 or 112	102 or 112	102 or 112	102 or 112
Width (mm)	50	50	50	55	55
Dry weight (kg)	2.58	3.19	4.19	5.17	6.54
Water content (ltrs)	0.40	0.49	0.60	0.85	0.97
Max no. factory built sections #	20	20	20	20	17

* A joining tool is required for on-site assembly for longer lengths than the factory maximum number of sections.

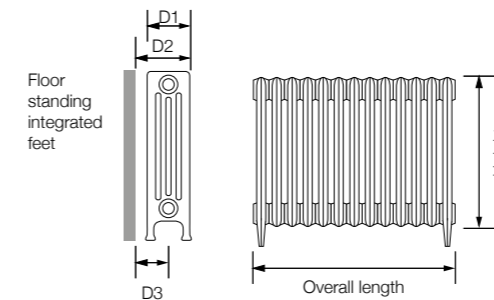

Joining key

Model / Code	ZXTOOL-01
Vecchio joining key	£160.00 ex VAT £192.00 inc VAT

We will always strive to keep on-site assembly to a minimum, but for radiators larger than the maximum factory assembled size (see charts above) on-site assembly will be required.

Full instructions and parts will be supplied, although a joining key tool will need to be purchased separately on a sale/return basis.

To calculate the length of the radiator, multiply the number of sections by the section width (see table above), then add 24mm for reducing bushes.

Please note there is a +/- 2mm manufacturers tolerance per section. We strongly recommend not setting pipework until the radiator has been delivered.

Calore

Calore cast iron radiators are a contemporary take on a classic design. Their purposeful stance makes them the centerpiece to any room, while a wide choice of finishes highlights their subtle details.



2 column shown here
in Light Old Penny with
Kentwell TRV satin valves,
pipe sleeves and wall stay

Material:	Operating up to:	Delivery:	Colours:	Guarantee:
CI	6bar	1 week*	chart 2	10 yrs

Calore 2 Column

The Calore 2 Column is perfect for maintaining the elegant aesthetic of cast iron in smaller rooms, or narrow spaces such as hallways.

Calore radiators are supplied as floor standing as standard. Wall mounted models are available by request at no extra cost.

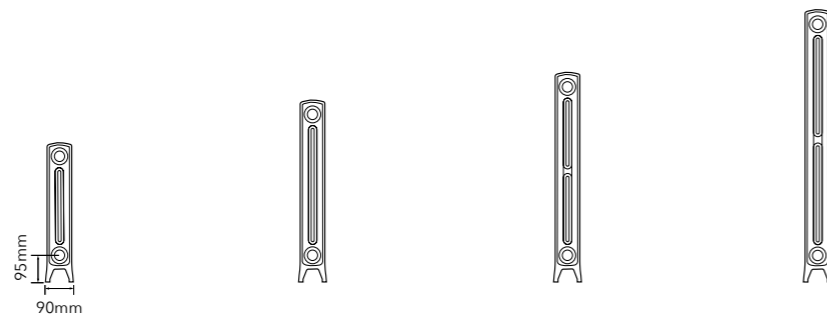

All information is per section	43/2	58/2	68/2	97/2
Primer (requires overpainting)	£25.60 ex VAT	£30.60 ex VAT	£37.40 ex VAT	£50.60 ex VAT
	£30.72 inc VAT	£36.72 inc VAT	£44.88 inc VAT	£60.72 inc VAT
Classic colour finish	£35.40 ex VAT	£40.40 ex VAT	£47.20 ex VAT	£60.40 ex VAT
	£42.48 inc VAT	£48.48 inc VAT	£56.64 inc VAT	£72.48 inc VAT
Special effects finish	£57.60 ex VAT	£62.60 ex VAT	£69.40 ex VAT	£82.60 ex VAT
	£69.12 inc VAT	£75.12 inc VAT	£83.28 inc VAT	£99.12 inc VAT
Height (mm)	490	640	740	1040
Output (watts @ Δt 50°C)	41.0	46.0	62.0	74.0
No. columns deep	2	2	2	2
Depth (mm) - D1	70	70	70	70
Depth (wall to face) (mm) - D2	102 or 112	102 or 112	102 or 112	176 or 186
Pipe centres from wall (mm) - D3	67 or 77	67 or 77	67 or 77	104 or 114
Width (mm)	60	60	60	60
Dry weight (kg)	2.60	3.41	3.82	5.15
Water content (L)	0.36	0.48	0.56	0.8
Max no. factory built sections #	20	20	20	17

* A joining tool is required for on-site assembly for longer lengths than the factory maximum number of sections.

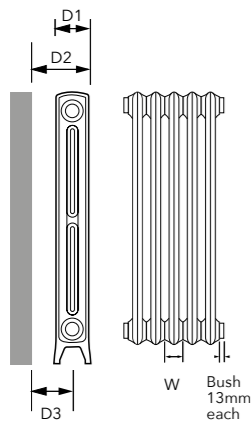

Joining key

Model / Code	ZXTOOL-02	
Calore joining key	£160.00 ex VAT	£192.00 inc VAT

We will always strive to keep on-site assembly to a minimum, but for radiators larger than the maximum factory assembled size (see charts above) on-site assembly will be required.

Full instructions and parts will be supplied, although a joining key tool will need to be purchased separately on a sale/return basis.

To calculate the length of the radiator, multiply the number of sections by the section width (see table above), then add 26mm for reducing bushes.

Please note there is a +/- 2mm manufacturers tolerance per section. We strongly recommend not setting pipework until the radiator has been delivered.



2 column wall mounted shown here in Matt Black with Chartwell TRV black nickel valves and pipe sleeves

Material:	Operating up to:	Delivery:	Colours:	Guarantee:
CI	6bar	1 week*	chart 2	10 yrs

Calore 4 Column

Our most popular model in the range, the Calore 4 Column balances the need for higher outputs in a small footprint by offering a wide variety of heights.

Calore radiators are supplied as floor standing as standard. Wall mounted models are available by request at no extra cost



Note: Column support positions may vary

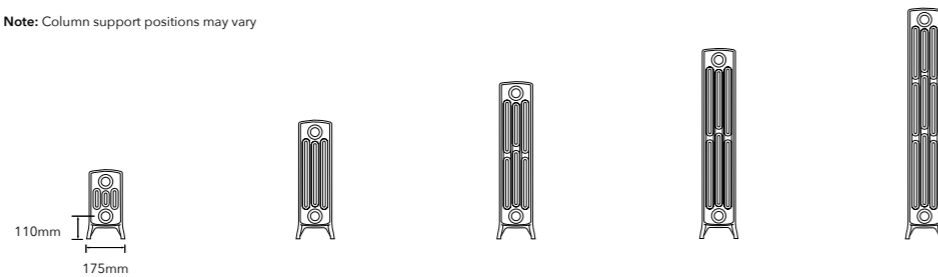

All information is per section	28/4	42/4	60/4	70/4	90/4
Primer (requires overpainting)	£27.80 ex VAT £33.36 inc VAT	£34.00 ex VAT £40.80 inc VAT	£41.80 ex VAT £50.16 inc VAT	£48.80 ex VAT £58.56 inc VAT	£60.20 ex VAT £72.24 inc VAT
Classic colour finish	£37.60 ex VAT £45.12 inc VAT	£43.80 ex VAT £52.56 inc VAT	£51.60 ex VAT £61.92 inc VAT	£58.60 ex VAT £70.32 inc VAT	£70.00 ex VAT £84.00 inc VAT
Special effects finish	£59.80 ex VAT £71.76 inc VAT	£66.00 ex VAT £79.20 inc VAT	£73.80 ex VAT £88.56 inc VAT	£80.80 ex VAT £96.96 inc VAT	£92.20 ex VAT £110.64 inc VAT
Height (mm)	357	475	660	760	960
Output (watts @ Δt 50°C)	43.6	65.1	93.0	107.8	138.7
No. columns deep	4	4	4	4	4
Depth (mm) - D1	144	144	144	144	144
Depth (wall to face) (mm) - D2	176 or 186	176 or 186	176 or 186	176 or 186	176 or 186
Pipe centres from wall (mm) - D3	104 or 114	104 or 114	104 or 114	104 or 114	104 or 114
Width (mm)	60	60	60	60	60
Dry weight (kg)	2.40	3.50	5.30	5.90	7.50
Water content (L)	0.35	0.51	0.85	0.97	1.10
Max no. factory built sections #	20	20	17	17	17

* A joining tool is required for on-site assembly for longer lengths than the factory maximum number of sections.



4 column shown here in Anthracite finish with Chartwell anthracite thermostatic valves and traditional anthracite pipe sleeves

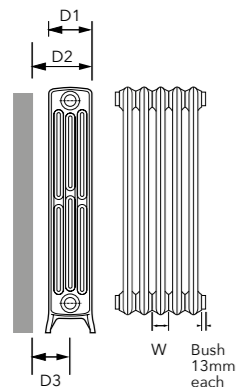

Joining key

Model / Code	ZXTOOL-02	
Calore joining key	£160.00 ex VAT	£192.00 inc VAT

We will always strive to keep on-site assembly to a minimum, but for radiators larger than the maximum factory assembled size (see charts above) on-site assembly will be required.

Full instructions and parts will be supplied, although a joining key tool will need to be purchased separately on a sale/return basis.

To calculate the length of the radiator, multiply the number of sections by the section width (see table above), then add 26mm for reducing bushes.

Please note there is a +/- 2mm manufacturers tolerance per section. We strongly recommend not setting pipework until the radiator has been delivered.

Material:	Operating up to:	Delivery:	Colours:	Guarantee:
CI	6bar	1 week*	chart 2	10 yrs

Calore 6 Column

For larger rooms, the Calore 6 Column delivers impressive outputs while still delivering a sophisticated and elegant aesthetic.

Calore radiators are supplied as floor standing as standard. Wall mounted models are available by request at no extra cost



Note: Column support positions may vary

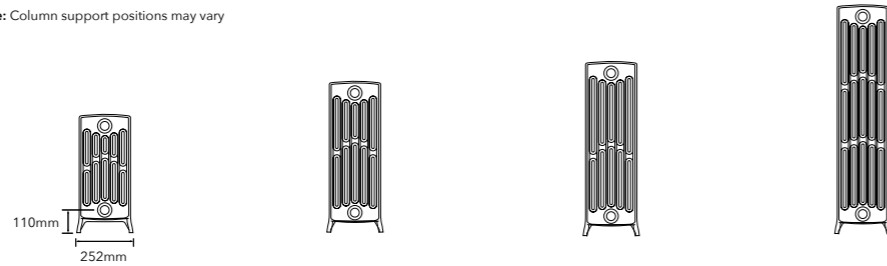

All information is per section	42/6	60/6	70/6	90/6
Primer (requires overpainting)	£48.80 ex VAT	£62.40 ex VAT	£78.00 ex VAT	£93.40 ex VAT
	£58.56 inc VAT	£74.88 inc VAT	£93.60 inc VAT	£112.08 inc VAT
Classic colour finish	£58.60 ex VAT	£72.20 ex VAT	£87.80 ex VAT	£103.20 ex VAT
	£70.32 inc VAT	£86.64 inc VAT	£105.36 inc VAT	£123.84 inc VAT
Special effects finish	£80.80 ex VAT	£94.40 ex VAT	£110.00 ex VAT	£125.40 ex VAT
	£96.96 inc VAT	£113.28 inc VAT	£132.00 inc VAT	£150.48 inc VAT
Height (mm)	485	660	760	960
Output (watts @ Δt 50°C)	95.3	133.0	151.0	197.0
No. columns deep	6	6	6	6
Depth (mm) - D1	221	221	221	221
Depth (wall to face) (mm) - D2	253 or 263	253 or 263	253 or 263	253 or 263
Pipe centres from wall (mm) - D3	142.5 or 152.5	142.5 or 152.5	142.5 or 152.5	142.5 or 152.5
Width (mm)	60	60	60	60
Dry weight (kg)	5.80	7.74	9.92	13.90
Water content (L)	0.85	1.20	1.40	1.50
Max no. factory built sections #	17	17	15	10

* A joining tool is required for on-site assembly for longer lengths than the factory maximum number of sections.

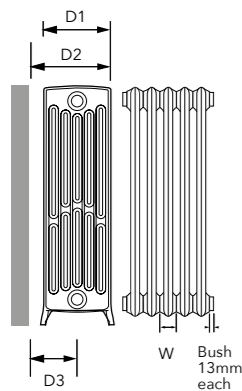

Joining key

Model / Code	ZXTOOL-02	
Calore joining key	£160.00 ex VAT	£192.00 inc VAT

We will always strive to keep on-site assembly to a minimum, but for radiators larger than the maximum factory assembled size (see charts above) on-site assembly will be required.

Full instructions and parts will be supplied, although a joining key tool will need to be purchased separately on a sale/return basis.

To calculate the length of the radiator, multiply the number of sections by the section width (see table above), then add 26mm for reducing bushes.

Please note there is a +/- 2mm manufacturers tolerance per section. We strongly recommend not setting pipework until the radiator has been delivered.

Calore 6 column shown here in Bronze finish with Nostalgia brass TRV valves and traditional brass pipe sleeves

Material:	Operating up to:	Delivery:	Colours:	Guarantee:
CI	6bar	1 week*	chart 2	10 yrs

Liscia 2 Column

Liscia is well suited to modern and traditional spaces with its rounded contours, crisp line detail and distinctive pinched top. This cast iron radiator effortlessly merges timeless charm with contemporary allure, reinventing the classic design for a modern era.

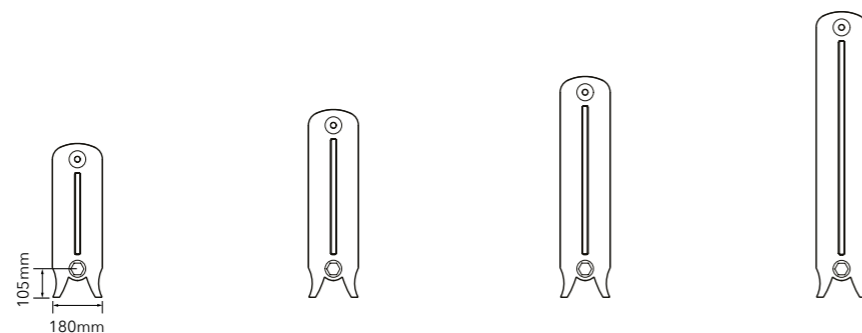

All information is per section	AST52/2	AST62/2	AST72/2	AST92/2
Primer (requires overpainting)	£76.60 ex VAT	£86.20 ex VAT	£102.00 ex VAT	£127.00 ex VAT
	£91.92 inc VAT	£103.44 inc VAT	£122.40 inc VAT	£152.40 inc VAT
Classic colour finish	£86.40 ex VAT	£96.00 ex VAT	£111.80 ex VAT	£136.80 ex VAT
	£103.68 inc VAT	£115.20 inc VAT	£134.16 inc VAT	£164.16 inc VAT
Special effects finish	£108.60 ex VAT	£118.20 ex VAT	£134.00 ex VAT	£159.00 ex VAT
	£130.32 inc VAT	£141.84 inc VAT	£160.80 inc VAT	£190.80 inc VAT
Height (mm)	520	620	720	920
Output (watts @ Δt 50°C)	86	103	124	149
No. columns deep	2	2	2	2
Depth (mm) - D1	180	180	180	180
Depth (wall to face) (mm) - D2	210 or 220	210 or 220	210 or 220	210 or 220
Pipe centres from wall (mm) - D3	120 or 130	120 or 130	120 or 130	120 or 130
Width (mm)	80	80	80	80
Dry weight (kg)	7.30	9.30	10.10	12.50
Water content (L)	2.13	2.61	3.05	4.14
Max no. factory built sections #	15	15	15	10

* A joining tool is required for on-site assembly for longer lengths than the factory maximum number of sections.

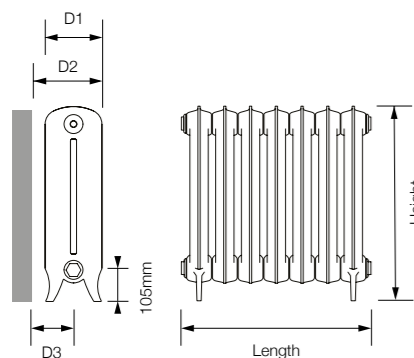

Joining key

Model / Code	ZXTOOL-02	
Liscia joining key	£160.00 ex VAT	£192.00 inc VAT

We will always strive to keep on-site assembly to a minimum, but for radiators larger than the maximum factory assembled size (see charts above) on-site assembly will be required.

Full instructions and parts will be supplied, although a joining key tool will need to be purchased separately on a sale/return basis.

To calculate the length of the radiator, multiply the number of sections by the section width (see table above), then add 26mm for reducing bushes.

Please note there is a +/- 2mm manufacturers tolerance per section. We strongly recommend not setting pipework until the radiator has been delivered.



Shown here in Beaten Brass finish with Kentwell angled TRV antique brass valves and pipe sleeves

Material:	Operating up to:	Delivery:	Colours:	Guarantee:
CI	6bar	1 week*	chart 2	10 yrs

Liscia 3 Column

Liscia is well suited to modern and traditional spaces with its rounded contours, crisp line detail and distinctive pinched top. This cast iron radiator effortlessly merges timeless charm with contemporary allure, reinventing the classic design for a modern era.

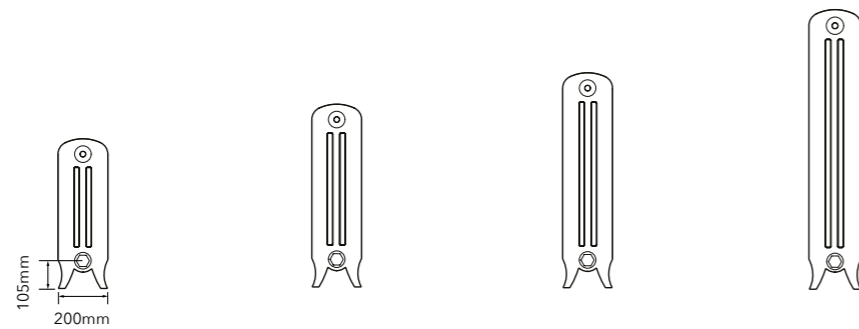

All information is per section	AST52/3	AST62/3	AST72/3	AST92/3
Primer (requires overpainting)	£90.40 ex VAT	£107.00 ex VAT	£121.00 ex VAT	£157.00 ex VAT
	£108.48 inc VAT	£128.40 inc VAT	£145.20 inc VAT	£188.40 inc VAT
Classic colour finish	£100.20 ex VAT	£116.80 ex VAT	£130.80 ex VAT	£166.80 ex VAT
	£120.24 inc VAT	£140.16 inc VAT	£156.96 inc VAT	£200.16 inc VAT
Special effects finish	£122.40 ex VAT	£139.00 ex VAT	£153.00 ex VAT	£189.00 ex VAT
	£146.88 inc VAT	£166.80 inc VAT	£183.60 inc VAT	£226.80 inc VAT
Height (mm)	520	620	720	920
Output (watts @ Δt 50°C)	97	119	138	176
No. columns deep	3	3	3	3
Depth (mm) - D1	200	200	200	200
Depth (wall to face) (mm) - D2	230 or 240	230 or 240	230 or 240	230 or 240
Pipe centres from wall (mm) - D3	130 or 140	130 or 140	130 or 140	130 or 140
Width (mm)	80	80	80	80
Dry weight (kg)	9.00	10.52	12.64	16.18
Water content (L)	2.10	2.60	2.90	3.80
Max no. factory built sections #	15	15	10	10

* A joining tool is required for on-site assembly for longer lengths than the factory maximum number of sections.

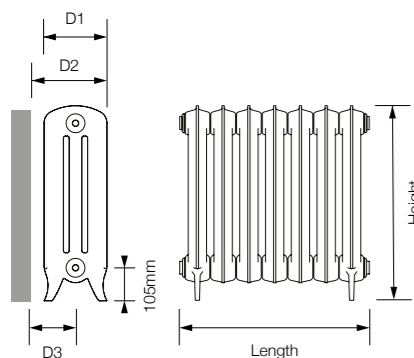

Joining key

Model / Code	ZXTOOL-02	
Liscia joining key	£160.00 ex VAT	£192.00 inc VAT

We will always strive to keep on-site assembly to a minimum, but for radiators larger than the maximum factory assembled size (see charts above) on-site assembly will be required.

Full instructions and parts will be supplied, although a joining key tool will need to be purchased separately on a sale/return basis.

To calculate the length of the radiator, multiply the number of sections by the section width (see table above), then add 26mm for reducing bushes.

Please note there is a +/- 2mm manufacturers tolerance per section. We strongly recommend not setting pipework until the radiator has been delivered.



Shown here in Black Chrome finish with Kentwell angled TRV black nickel valves, pipe sleeves and air vent



CHART TWO

Due to the limitations of the printing process, finished product colour may vary from this publication. If you would like a colour swatch, please contact head office.

Classic colour finishes



RAL 9016
Traffic White (semi-gloss)



RAL 9010
Warm White (semi-gloss)

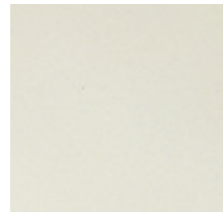

RAL 9001
Cream White (semi-gloss)



RAL 1013
Pearl White (semi-gloss)

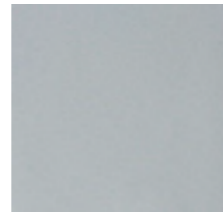

RAL 7035
Light Grey (semi-gloss)

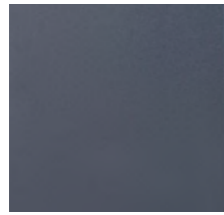

RAL 7015
Slate Grey (semi-gloss)



RAL 7016
Anthracite Grey (semi-gloss)

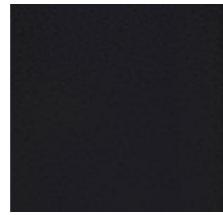

Black (matt)



RAL 3003
Flame Red (semi-gloss)



RAL 9007
Grey Aluminium (semi-gloss)

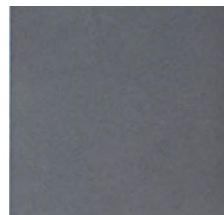

RAL 9023
Pearl Dark Grey (semi-gloss)



Anthracite (matt)

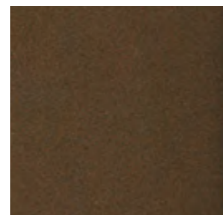

Light Old Penny (matt)

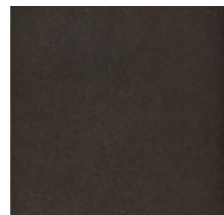

Dark Old Penny (matt)

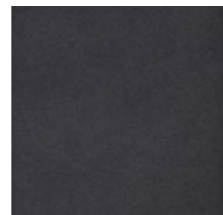

Natural Cast Iron (matt)

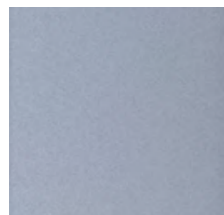

Pewter (matt)

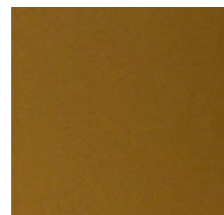

Antique Gold (matt)

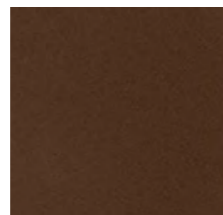

Bronze (gloss)

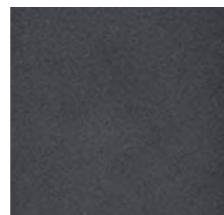

Gun Metal (matt)

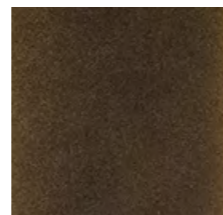

Beaten Brass (semi-gloss)

Special effects finishes



Stone



Black Chrome



Chrome Effect



Brass



Rose Gold



Corten



Blue Chrome

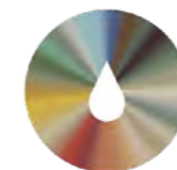

COLOUR MATCHING

If you're looking for a colour other than those shown in our colour chart, we can finish your radiator to any RAL colour in gloss, semi-gloss or matt finish. We also offer a colour match to most designer paint brands. Colours outside of our colour chart carry a £32 ex VAT (£38.40 inc VAT) special mixing charge.

